



NATIONAL ENTRANCE SCREENING TEST

NEST 2021

Participant ID	
Participant Name	
Test Center Name	
Test Date	14/08/2021
Test Time	9:00 AM - 12:30 PM
Subject	NEST 2021

Section : **Biology**

Q.1 Similarity between DNA sequences of two eukaryotic species is used to predict their evolutionary relatedness, pointing to a shared ancestry. In an attempt to evaluate this relatedness, a group of researchers sequenced and compared two proteins with the same function from the two species. The corresponding DNA and RNA sequences were also compared to decipher their relatedness. Based on this information, the correct option is

Ans ✓ 1.

Similarity in exons, but not necessarily in introns, is reflective of divergent evolution.

✗ 2.

Similarity in the protein sequence, but not in the corresponding RNA or DNA sequence can be an example of divergent evolution.

✗ 3.

Similarity in introns, but not in exons, is reflective of convergent evolution.

✗ 4.

Though the overall protein sequences are not similar, the conservation of active site residues cannot be due to convergent evolution.

Question Type : **MCQ**

Question ID : **4146641009**

Status : **Answered**

Chosen Option : **4**

Marks : **-1**

Q.2 The deletion of a segment of mitochondrial DNA, specifically in the mature sperm of Mr. **P** led to infertility. This deletion results in the lack of a mitochondrial transport protein **X** critical for ATP production. Mr. **P** was referred to an Assisted-Reproduction Centre for several remedial possibilities. Based on this information, the correct option is

Ans  1.

The somatic cells of the male progeny of Mr. **P** resulting from *in vitro* fertilization will inherit defective mitochondria.

 2.

An Intra-Cytoplasmic Sperm Injection procedure followed by Zygote Intra-Fallopian Transfer will help Mr. **P** father a baby.

 3.

Treating Mr. **P** with a compound that stabilizes the defective protein **X** will restore ATP production and fertility.

 4.

Mr. **P** has an X-linked genetic disorder and therefore can father a baby only with a genetically compatible female.

Question Type : **MCQ**

Question ID : **4146641007**

Status : **Answered**

Chosen Option : **2**

Marks : **2.5**

Q.3 The pathway that determines skin pigmentation in dogs is governed by two unlinked genes (**I** and **II**). While gene **I** determines the type of pigment, gene **II** is responsible for its deposition in skin cells. Allele **P** (gene **I**) results in a black pigment; whereas, **p** produces a brown pigment. While allele **Q** (gene **II**) results in the deposition of pigment, **q** will not allow the same. Alleles **P** and **Q** are dominant over **p** and **q**, respectively. Lack of pigment deposition results in an albino phenotype. When two canines with genotype **PpQq** are mated, the phenotypic ratios of offspring would be

Ans  1.

12(black):3(brown):1(albino)

 2.

9(black):3(brown):4(albino)

 3.

9(black):7(albino)

 4.

12(black):4(brown)

Question Type : **MCQ**





Question ID : **4146641008**

Status : **Answered**

Chosen Option : **4**

Marks : **-1**

Q.4 A leaf-infecting fungus secretes a chemical that causes the guard cells to remain open thereby enabling the fungus to enter the plant tissue through the stomata. The most likely function of this chemical is

- Ans**
-  1. importing sodium ions into the guard cells.
 -  2. exporting potassium ions out of the guard cells.
 -  3. exporting water molecules out of the guard cells.
 -  4. importing potassium ions into the guard cells.

Question Type : **MCQ**

Question ID : **4146641001**

Status : **Answered**

Chosen Option : **4**

Marks : **2.5**

Q.5 Three different proteins (**X**, **Y** and **Z**) that are known to be transported from the cytoplasm into different organelles were studied. Protein **X** was found to be localized in the matrix of mitochondria, protein **Y** inside the lumen of endoplasmic reticulum and protein **Z** in the nucleoplasm. Based on this information, the correct option is

Ans  1.

While **X** and **Z** have to cross two bilayers, **Y** has to cross one bilayer.

 2.

While **X** and **Y** have to cross two bilayers, **Z** has to cross one bilayer.

 3.

All the three proteins **X**, **Y** and **Z** have to cross two bilayers.

 4.

While **Y** and **Z** have to cross two bilayers, **X** has to cross one bilayer.

Question Type : **MCQ**

Question ID : **4146641004**

Status : **Answered**

Chosen Option : **1**

Marks : **2.5**

Q.6 Statements about the effect of CO₂ concentration, temperature and light intensity on the rate of photosynthesis in C3 and C4 plants are given. Based on the statements the correct option is

- i) At high CO₂ concentrations, 40°C and saturated light, the photosynthetic rates of C3 and C4 plants are similar.
- ii) C4 plants do not reach saturation levels even at 10% of the full intensity of sunlight.
- iii) At twice the levels of CO₂ concentration (~700 ppm), the net photosynthesis in C3 plants is higher than that of C4 plants.
- iv) The net CO₂ uptake in a C3 shade plant is equivalent to C4 plant under light saturation condition.

Ans  1. Only ii

 2. i, ii, iii

 3. Only i

 4. i, ii, iii, iv

Question Type : **MCQ**

Question ID : **4146641002**

Status : **Answered**

Chosen Option : **4**

Marks : **-1**

Q.7 A linear double-stranded DNA was completely digested using either one or two restriction endonucleases (*Cfr10I* and *BanII*). The sequence of one of the strands is provided. The restriction site for *Cfr10I* is **RCCGGY** and for *BanII* is **GRGCYC** (**R** is A or G and **Y** is T or C).

5'TGGAGAGACCGGTAGCAGAGAGCTCCATTCCGGGCGCGCCGGCACCCCTTAGGA3'

Based on this information, the correct option is

Ans  1.

Digestion with both *Cfr10I* and *BanII* will generate three fragments.

 2.

Digestion with both *Cfr10I* and *BanII* will generate four fragments.

 3.

Digestion with *BanII* will generate one fragment.

 4.

Digestion with *Cfr10I* will generate two fragments.

Question Type : **MCQ**

Question ID : **4146641003**

Status : **Answered**

Chosen Option : **2**

Marks : **2.5**

Q.8 Bacteria can be divided into four groups based on the optimal temperatures under which they grow: psychrophiles (5-20°C), mesophiles (20-40°C), facultative thermophiles (40-65°C) and thermophiles (60-90°C). Based on this information, the option that gives the best match is

	Type of bacteria		Characteristic feature
i.	Thermophiles	p.	are mostly human pathogens
ii.	Mesophiles	q.	cause refrigerated food to spoil
iii.	Psychrophiles	r.	cannot survive pasteurization
iv.	Facultative thermophiles	s.	found in deep sea vents

Ans  1.

i-s; ii-p; iii-q; iv-r

 2.

i-r; ii-p; iii-q; iv-s

 3.

i-s; ii-q; iii-p; iv-r

 4.

i-r; ii-q; iii-p; iv-s

Question Type : **MCQ**

Question ID : **4146641010**

Status : **Answered**

Chosen Option : **1**

Marks : **2.5**

Q.9 When a 100 mL of *Escherichia coli* culture is grown at 37°C under laboratory conditions, the population of cells exhibit four distinct phases (Figure P): (i) lag phase, wherein cells adapt to the environment, (ii) exponential phase, wherein cells undergo rapid division, and the population keeps doubling, (iii) stationary phase, wherein the rate of cell division decreases and some cells begin to die, (iv) death phase commences (much before cell lysis), wherein the rate of cell death exceeds the rate of cell division. The two curves in the graph indicate the methods used to measure growth, viz. turbidity method (optical density) and counting colonies on a solid nutrient medium, wherein each live cell grows into an individual colony termed as a colony forming unit (CFU). The death phase remains constant in the turbidity method even though the number of live bacteria decreases, because

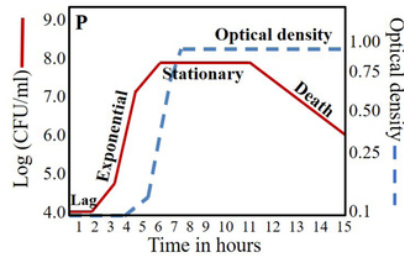

Ans 1.

live cells do not contribute to the optical density.

2.

dead cells also contribute to the optical density.

3.

only live cells contribute to the optical density.

4.

CFU is a measure of both live and dead cells.

Question Type : MCQ

Question ID : 4146641005

Status : Answered

Chosen Option : 3

Marks : -1

Q.10 Tetanus is caused by a toxin secreted by the bacterium *Clostridium tetani*. If a person infected with *Clostridium tetani* manifests early symptoms of tetanus, then the injection which will be immediately effective is

Ans  1.

antibiotic.

 2.

tetanus toxoid.

 3.

tetanus antiserum.

 4.

inactivated *Clostridium tetani* bacteria.

Question Type : **MCQ**

Question ID : **414664999**

Status : **Answered**

Chosen Option : **4**

Marks : **-1**

Q.11

The quantities K_m and V_{max} were measured independently for an enzymatic reaction using enzymes **E1**, **E2**, **E3** and **E4** isolated from four different organisms (Table). For each enzymatic reaction, 0.5 mM substrate was used to obtain the product. The correct option in terms of product formation is

Enzyme	K_m (mM)	V_{max} (mM/s)
E1	0.2	500
E2	0.8	100
E3	0.8	500
E4	0.2	100

Ans  1.

E2 is better than **E1**, **E3** and **E4**.

 2.

E3 is better than **E1**, **E2** and **E4**.

 3.

E1 is better than **E2**, **E3** and **E4**.

 4.

E4 is better than **E1**, **E2** and **E3**.

Question Type : **MCQ**

Question ID : **4146641006**

Status : **Answered**

Chosen Option : **2**

Marks : **-1**

Q.12 Deep-sea divers are trained to hold their breath under water for an extended period by practicing hyperventilation exercises before the dive. The partial pressures of O_2 (pO_2) and CO_2 (pCO_2) in blood was measured and the results of breath-hold exercises are depicted (Graph). The correct option that best matches column I with II is

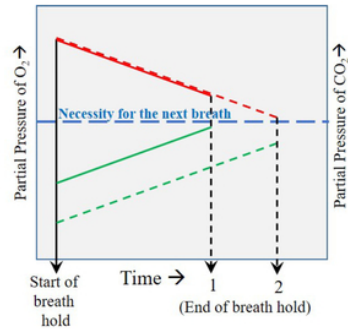

Column I	Column II
(i) red lines (solid and dotted)	(u) pCO_2
(ii) green lines (solid and dotted)	(v) hyperventilated state
(iii) colored dotted lines (red and green)	(w) normal breathing
(iv) colored solid lines (red and green)	(x) pO_2

- Ans**
- ✓ 1. i-x; ii-u; iii-v; iv-w
 - ✗ 2. i-u; ii-x; iii-w; iv-v
 - ✗ 3. i-u; ii-x; iii-v; iv-w
 - ✗ 4. i-x; ii-u; iii-w; iv-v

Question Type : **MCQ**
 Question ID : **4146641000**
 Status : **Answered**
 Chosen Option : **1**
 Marks : **2.5**

Q.13 In the given pedigree, circles represent females and squares represent males. Filled shapes indicate affected individuals; while, unfilled shapes indicate unaffected individuals for a particular disease controlled by gene **P**.

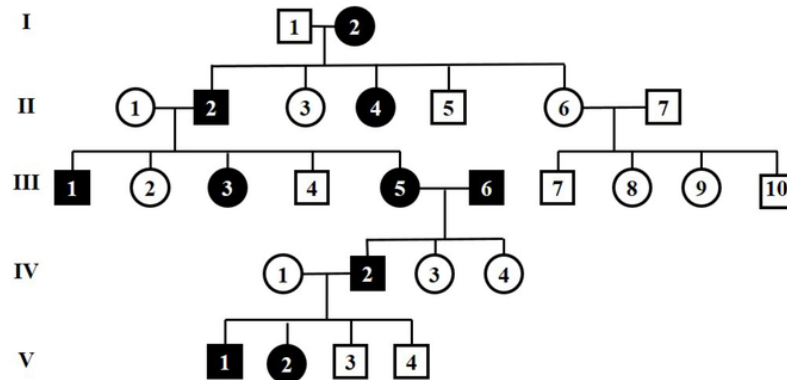

- i. X-linked dominant
- ii. Autosomal dominant
- iii. Autosomal recessive
- iv. The genotype of I-2 is Pp or PP
- v. The genotypes of II-2 and III-5 are same for the trait
- vi. The genotype of II-7 is Pp or PP

Analyse the inheritance pattern along with the genotype (**P** is dominant allele and **p** is recessive allele) and choose the correct option(s).

- Ans**
- 1. ii and iv
 - 2. iii and vi
 - 3. ii and v
 - 4. i and vi

Question Type : **MSQ**
 Question ID : **4146641015**
 Status : **Answered**
 Chosen Option : **1,3**
 Marks : **0**

Q.14 Compared to differentiated cells, stem cells have a longer interphase. Three different human alveolar cell-types (stem cells, normal cells and cancer cells) grown under optimal laboratory conditions were examined microscopically (Figure). The nucleus was stained blue and phos-H2A.X protein green. Phos-H2A.X is found only at damaged DNA site *in vivo*. Each green dot is considered as an event of DNA damage or a cluster of events called foci. Based on the comparison of the results between these three cell types, choose the correct option(s).

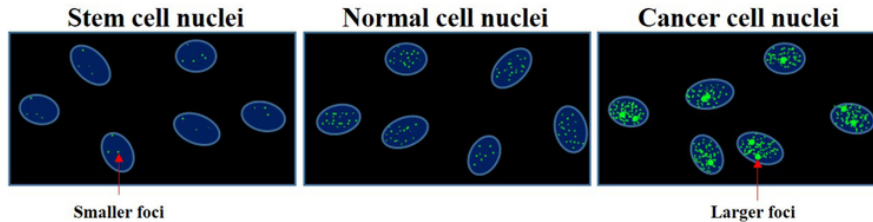

Ans 1.

Although carcinogens damage DNA, cellular processes do not lead to such damages.

2.

The rate of cell division can be directly correlated to the number of DNA breaks.

3.

The experiment clearly indicates that the M-phase of the three cell types is different.

4.

The rate of DNA damage is inversely proportional to its occurrence in cancer cells.

Question Type : **MSQ**

Question ID : **4146641013**

Status : **Answered**

Chosen Option : **2,3**

Marks : **0**

Q.15

Escherichia coli strains (I-IV) with mutations in the *lac* operon were studied for β -galactosidase activity, followed by measuring its mRNA and protein levels (Graphs). The arrow indicates the time of addition of a compound (namely IPTG) that induces the *lac* operon. Based on the results, the correct option(s) is(are)

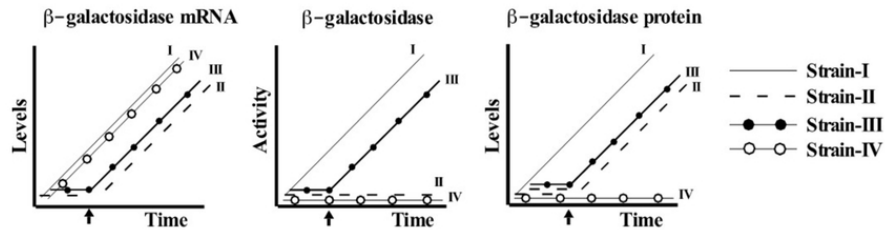

Ans ~~1.~~

In strain-I, the *lac* operon is not regulated and β -galactosidase is inactive.

~~2.~~

In strain-II, the *lac* operon is not regulated and β -galactosidase is inactive.

✓ 3.

In strain-IV, the *lac* operon is not regulated and β -galactosidase protein is not produced.

✓ 4.

In strain-III, the *lac* operon is regulated and β -galactosidase is active.

Question Type : MSQ

Question ID : 4146641014

Status : Answered

Chosen Option : 3,4

Marks : 4

Q.16 Coffee leaf rust is caused by the fungus *Hemileia vastatrix*. *Lecanicillium lecanii*, a saprophytic fungus is often found on the coffee leaves because it is able to colonize and consume *H. vastatrix*. In addition, *L. lecanii* infection routinely spreads among *Coccus viridis*, another pest of coffee. *C. viridis* are often found in large numbers near the nest of the ants (*Azteca instabilis*) which offers protection to *C. viridis* from its predators. In turn, the honeydew secreted from *C. viridis* is utilized as a source of food by the ants. Based on these interactions, choose the correct option(s).

Ans ✓ 1.

An increase in ant population has a positive effect on coffee plantation.

✗ 2.

A curative eradication of *H. vastatrix* will decrease the number of *C. viridis*.

✓ 3.

Infection rate of *L. lecanii* in *C. viridis* is low because of their scanty numbers, except near the nest of ants.

✓ 4.

An increase in *A. instabilis* numbers has an indirect negative effect on *H. vastatrix*.

Question Type : **MSQ**

Question ID : **4146641011**

Status : **Answered**

Chosen Option : **1,4**

Marks : **0**

Q.17 An autosomal dominant muscular dystrophy is caused by a decrease in the repeat number of a VNTR present on chromosome 4 of humans. Each repeat is 2.5 kilo base pairs (kbp). If the repeat number is 1 to 15, then an individual manifests the disease. However, individuals with repeat numbers zero or more than 15, will not manifest the disease. Using Southern hybridization technique, a diagnostic test was performed for four individuals (**P1**, **P2**, **P3** and **P4**) and the results are shown (Diagram **Y**). The schematic (**X**) shows VNTR-containing region of chromosome 4 and the position of Southern hybridization probe. The probe can hybridize with the VNTR and an adjacent 1 kbp sequence. Based on these results, the individual(s) that can manifest this disease is(are)

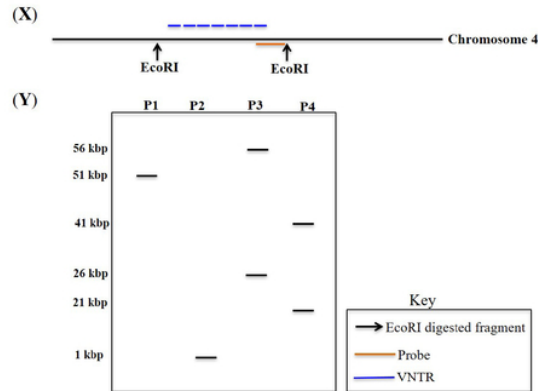

- Ans ~~1.~~
P2
✓ 2.
P4
✓ 3.
P3
~~4.~~
P1

Question Type : **MSQ**
Question ID : **4146641012**
Status : **Answered**
Chosen Option : **3,4**
Marks : **0**

Q.1 Peroxodisulphuric acid

Ans  1.

has 12 electrons around the S atom.

 2.

is a monobasic acid.

 3.

converts sulphate ion to sulphite ion.

 4.

is prepared by absorption of SO_3 in H_2SO_4 .

Question Type : MCQ

Question ID : 4146641018

Status : Answered

Chosen Option : 4

Marks : -1

Q.2 XeF_4 reacts with SbF_5 to form an adduct $[\text{XeF}_3]^+ [\text{SbF}_6]^-$. The shape/geometry around the Xe and Sb ions, in the adduct, are respectively

Ans

 1. Pyramidal & Octahedral.

 2. Trigonal & Octahedral.

 3. Trigonal & Trigonal bipyramidal.

 4. T-Shaped & Octahedral.

Question Type : **MCQ**

Question ID : **4146641021**

Status : **Answered**

Chosen Option : **4**

Marks : **2.5**

Q.3 The elevation of boiling point and depression of freezing point of a certain solution of a monobasic acid HA in benzene are ΔT_b and ΔT_f , respectively. HA exists usually as a monomer, but it dissociates into ions (with degree of dissociation α) at the boiling point T_b of the solution, whereas at the freezing point T_f of the solution, HA exists as $(HA)_n$ with a fixed value of n . The molal boiling point elevation constant and molal freezing point depression constant are K_b and K_f , respectively. The correct expression for n is

Ans  1.

$$n = [\Delta T_b K_f (1+\alpha)] / (\Delta T_f K_b)$$

 2.

$$n = [\Delta T_b K_b (1+\alpha)] / (\Delta T_f K_f)$$

 3.

$$n = (\Delta T_b K_f) / [\Delta T_f K_b (1+\alpha)]$$

 4.

$$n = (\Delta T_b K_b) / [\Delta T_f K_f (1+\alpha)]$$

Question Type : MCQ

Question ID : 4146641025

Status : Answered

Chosen Option : 2

Marks : -1

Q.4 AlCl_3 in an acidified aqueous solution forms an Al^{3+} complex. In this complex ion, the hybridization of Al is

Ans

 1. dsp^2

 2. sp^3d

 3. sp^2

 4. sp^3d^2

Question Type : **MCQ**

Question ID : **4146641020**

Status : **Answered**

Chosen Option : **1**

Marks : **-1**

Q.5 Assume that fullerene (C_{60}) in gas phase behaves as a van der Waals gas. The van der Waals constant, b , for fullerene gas is $1.01 \times 10^{-2} \text{ m}^3 \text{ mol}^{-1}$. The correct statement about fullerene is

Ans  1.

The radius of C_{60} molecule is approximately 10 nm.

 2.

The volume of fullerene gas will always be larger if it behaves as an ideal gas at same P and T.

 3.

The volume of one mole of C_{60} molecules is 8 times of the van der Waals constant, b , of the fullerene gas.

 4.

The radius of C_{60} molecule is approximately 10\AA .

Question Type : **MCQ**

Question ID : **4146641027**

Status : **Not Answered**

Chosen Option : --

Marks : **0**

Q.6 The reagent that can transform benzene-1,2-dicarbaldehyde to sodium 2-(hydroxymethyl) benzoate is

Ans

- ✓ 1. Conc. aq NaOH
- ✗ 2. LiAlH_4 in diethyl ether
- ✗ 3. NaBH_4 in ethanol
- ✗ 4. $\text{C}_2\text{H}_5\text{ONa}$ in ethanol

Question Type : **MCQ**

Question ID : **4146641024**

Status : **Not Answered**

Chosen Option : --

Marks : **0**

Q.7 The anti-COVID-19 drug 2-DG is recently developed by the Institute of Nuclear Medicine and Allied Sciences (INMAS), Defence Research and Development Organization (DRDO) in collaboration with Dr Reddy's Laboratories (DRL). The drug is -

Ans

- ✓ 1. 2-Deoxy-D-Glucose.
- ✗ 2. 2-Dioxy-D-Glucose.
- ✗ 3. 2-Deoxy-L-Glucose.
- ✗ 4. 2-Dioxy-L-Glucose.

Question Type : **MCQ**

Question ID : **4146641016**

Status : **Not Answered**

Chosen Option : --

Marks : **0**

Q.8 The correct statement regarding a soap solution in water at a low concentration is

Ans  1.

The anions of the soap molecules are present in the bulk of the solution with their ionic ends as well as tails in water.

 2.

The anions of the soap molecules are present at the surface of the solution with their ionic ends as well as tails staying away from the water.

 3.

The anions of the soap molecules are present at the surface of the solution with their ionic ends in water and tails staying away from the water.

 4.

The anions of the soap molecules are present at the surface of the solution with their tails in water and ionic ends staying away from the water.

Question Type : **MCQ**

Question ID : **4146641017**

Status : **Answered**

Chosen Option : **3**

Marks : **2.5**

Q.9 Let the ground state electronic energy of hydrogen atom be E_H eV. The first excited state energy of deuterium atom (in eV) is

Ans

✗ 1. $E_H/4$

✗ 2. $E_H/2$

✓ 3. lower than $E_H/4$

✗ 4. higher than $E_H/4$

Question Type : **MCQ**

Question ID : **4146641026**

Status : **Answered**

Chosen Option : **1**

Marks : **-1**

Q.10 The correct order of the calculated spin-only magnetic moment for the selected first row transition metal ions is

Ans

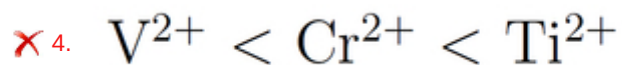
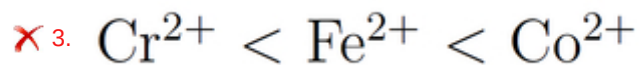
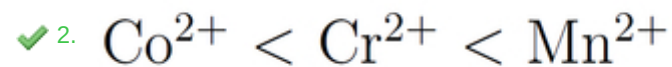

Question Type : **MCQ**

Question ID : **4146641019**

Status : **Answered**

Chosen Option : **2**

Marks : **2.5**

Q.11

A mixture containing almost equal quantities of all dimethylbenzenes is reacted with two equivalents of methyl chloride in the presence of anhydrous aluminium chloride. The main product formed is

Ans

 1. hexamethylbenzene.

 2. 1,2,4,5-tetramethylbenzene.

 3. 1,2,3,4-tetramethylbenzene.

 4.

a mixture of tetramethylbenzenes.

Question Type : **MCQ**

Question ID : **4146641022**

Status : **Answered**

Chosen Option : **4**

Marks : **-1**

Q.12 One mole of *d*-2-bromobutane is hydrolysed in an alkaline medium to form butane-2-ol. The rate of formation of *l*-butane-2-ol is assumed to be twice that of *d*-butane-2-ol. The specific rotation of *d*-butane-2-ol is $+13.5^\circ$. After complete reaction, the specific rotation of the product mixture is

Ans

✓ 1. $- 4.5^\circ$

✗ 2. $+ 4.5^\circ$

✗ 3. $+ 13.5^\circ$

✗ 4. $- 5.5^\circ$

Question Type : **MCQ**

Question ID : **4146641023**

Status : **Not Answered**

Chosen Option : --

Marks : **0**

Q.13 Molecular orbitals are formed by the overlap of suitable atomic orbitals from different atoms. Symmetry and energies of the overlapping orbitals and distance between the approaching atoms are crucial for the formation of molecular orbitals. For diatomic molecules, by convention, the internuclear axis is taken to be in the z-direction. Correct statement(s) is /are

Ans ✓ 1.

Molecular orbitals formed from $2p_x$ orbitals are not symmetrical around the internuclear axis.

✓ 2.

$2s$ and $2p_z$ orbitals can overlap to form a bonding orbital.

✗ 3.

Overlap of two $2p_x$ orbitals will always form a stronger bond than overlap of two $2p_z$ orbitals.

✓ 4.

Linear combination of two $2p_z$ orbitals can produce a σ molecular orbital.

Question Type : **MSQ**

Question ID : **4146641028**

Status : **Answered**

Chosen Option : **2,4**

Marks : **0**

Q.14 One litre of water is kept in a closed two litre vessel at temperature T with no air in the space above the liquid (System 1). Another identical system is prepared but there is air above the liquid (System 2). Assuming water vapour as well as air to behave as ideal gases and water to be in equilibrium with the vapour above the liquid, the correct statement(s) is/are

Ans ✓ 1.

The total pressure of gas (water vapour and air) in System 2 increases nonlinearly with T .

✓ 2.

The partial pressure of water vapour in System 2 is same as the pressure in System 1.

✓ 3.

The pressure of water vapour in System 1 increases nonlinearly with T .

✗ 4.

The pressure of water vapour in System 1 increases linearly with T .

Question Type : **MSQ**

Question ID : **4146641031**

Status : **Answered**

Chosen Option : **1,4**

Marks : **0**

Q.15 The steps, in one of the possible reaction mechanisms, corresponding to the preparation of acetone from isopropyl alcohol by using CrO_3 and conc. H_2SO_4 are mentioned below.

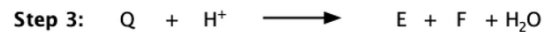
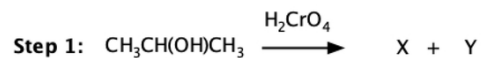

Here, Z is H_3O^+ , E and F are Cr-containing species, and Step 3 is a disproportionation reaction. The correct statement(s) is/are

Ans ✓ 1.

Y = H_2O and X contains chromium in oxidation state +6.

✓ 2.

Oxidation states of chromium in E and F are +6 and +3.

✗ 3.

In Step 2, water acts as an acid.

✓ 4.

Oxidation state of chromium in the compound Q is +4.

Question Type : **MSQ**

Question ID : **4146641030**

Status : **Answered**

Chosen Option : **1,4**

Marks : **0**

Q.16 In the addition reaction of propene with bromine water, propene first reacts with Br_2 to form the bromonium ion intermediate and bromide ion. The intermediate then reacts with $\text{Br}^-/\text{H}_2\text{O}$ to form different products as shown below.

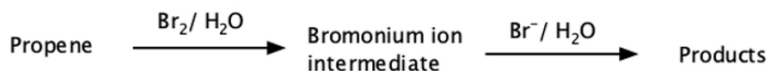

The intermediate is formed by conversion of one π -bond of propene to two σ bonds, connecting Br^+ with two carbon atoms. One of the factors governing the yield of the product from the intermediate is the concentration of the nucleophile. The correct statement(s) is/are

Ans  1.

1,2-Dibromopropane is the major product.

 2.

The hybridization of bromine in the intermediate is sp^3

 3.

1-Bromopropan-2-ol is the major product.

 4.

Total number of optical isomers in the product mixture is six.

Question Type : **MSQ**

Question ID : **4146641029**

Status : **Answered**

Chosen Option : **1,2**

Marks : **0**

Q.17 The rate (r) of a chemical reaction is plotted against time (t) in graph 1. The initial rate of the reaction is r_0 . The plot of $\ln(r/r_0)$ with time is shown in graph 2. The correct statement(s) is/are

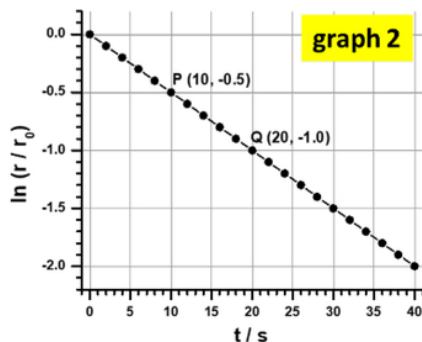
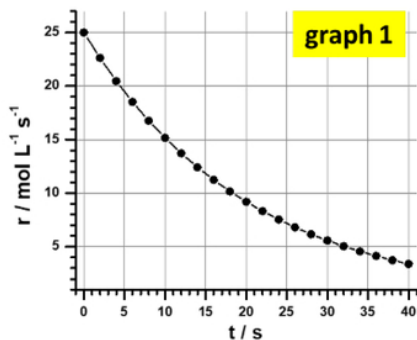

Ans ~~X~~ 1.

The rate (r) always decreases with time irrespective of the order of the reaction.

✓ 2.

After 69.3 s, the concentration of the reactant will be reduced to $(1/32)$ times of its initial concentration.

✓ 3.

Both the graphs represent the kinetics of a first order reaction.

✓ 4.

Initial concentration of the reactant is 500 mol L^{-1} .

Question Type : MSQ

Question ID : 4146641032

Status : Answered

Chosen Option : 1,3

Marks : 0

Q.1 Suppose f is a differentiable function on $[0, 1]$, such that the derivative of f is continuous on $[0, 1]$. Let $f(1) = 6$ and $f(0) = 1$. Then $\lim_{n \rightarrow \infty} \frac{1}{n} \sum_{k=1}^n f\left(\frac{k}{n}\right) f'\left(\frac{k}{n}\right)$ is

Ans

✓ 1. $\frac{35}{2}$

✗ 2. $\frac{25}{2}$

✗ 3. 5

✗ 4. 0

Question Type : **MCQ**

Question ID : **4146641038**

Status : **Not Answered**

Chosen Option : --

Marks : **0**

Q.2

Ameeya has 25 cards, each having a different integer from 1 to 25 printed on it. He wishes to place N cards in a single row so that the numbers on every pair of adjacent cards have a prime factor in common. The largest value of N for which this is possible is

Ans

 1. 18

 2. 20

 3. 16

 4. 22

Question Type : **MCQ**

Question ID : **4146641033**

Status : **Not Answered**

Chosen Option : --

Marks : **0**

Q.3

Let ω be a cube root of 1, which is different from 1. Then the value of $(1 + \omega^{2021})^{2021}$ is

Ans

 1. ω

 2. ω^2

 3. $-\omega^2$

 4. $-\omega$

Question Type : **MCQ**

Question ID : **4146641035**

Status : **Answered**

Chosen Option : **2**

Marks : **-1**

Q.4 Five friends have the following hobbies :
Akshay likes singing and cooking, Bharati likes singing and painting, Charu likes painting and cooking, Disha likes gardening and singing and Farah likes cooking and gardening. The two hobbies (amongst singing, cooking, painting and gardening), which are least popular with these friends are

- Ans**
- 1. painting and cooking
 - 2. painting and singing
 - 3. painting and gardening
 - 4. cooking and singing

Question Type : **MCQ**
Question ID : **4146641034**
Status : **Answered**
Chosen Option : **3**
Marks : **2.5**

Q.5 A pair of positive integers (m, n) is said to be a happy pair if $\gcd(m, n)$ is a perfect square. Suppose k is a positive integer such that $(205800, 35k)$ is a happy pair. Then the number of possible values of k with $k \leq 2940$ is

Ans

 1. 27

 2. 36

 3. 30

 4. 28

Question Type : **MCQ**

Question ID : **4146641039**

Status : **Not Answered**

Chosen Option : --

Marks : **0**

Q.6 Let $\{a_n | n \in \mathbb{N}\}$ and $\{b_n | n \in \mathbb{N}\}$ be two sets of real numbers, where \mathbb{N} denotes the set of natural numbers. Define $s_k = \sum_{i=1}^k a_i$ and $t_k = \sum_{i=1}^k b_i$. Then $\sum_{i=1}^k a_i b_i$ is equal to

Ans

✓ 1. $\sum_{i=1}^{k-1} s_i(b_i - b_{i+1}) + s_k b_k$

✗ 2. $\sum_{i=1}^{k-1} t_i(a_i + a_{i+1}) + t_k a_k$

✗ 3. $\sum_{i=2}^k s_i(b_i - b_{i-1}) + s_1 b_1$

✗ 4. $\sum_{i=2}^k t_i(a_i - a_{i-1}) + t_1 a_1$

Question Type : **MCQ**

Question ID : **4146641042**

Status : **Not Answered**

Chosen Option : --

Marks : **0**

Q.7

The number of roots of the equation

$$x^2 + \cos^2 x = 1$$

in the interval $[0, \frac{\pi}{2}]$ is

Ans

 1. 0

 2. 1

 3. 3

 4. 2

Question Type : **MCQ**

Question ID : **4146641040**

Status : **Answered**

Chosen Option : **1**

Marks : **-1**

Q.8

Let a, b, c be real numbers each greater than 1 and let

$$\frac{2}{3} \log_b a + \frac{3}{5} \log_c b + \frac{5}{2} \log_a c = 3.$$

If $b = 9$, then a must equal

Ans

✗ 1. $\frac{27}{2}$

✗ 2. 3

✗ 3. 18

✓ 4. 27

Question Type : MCQ

Question ID : 4146641041

Status : Not Answered

Chosen Option : --

Marks : 0

Q.9

Let α and β be two roots of $3\cos\theta + 4\sin\theta = \frac{7}{2}$. If $\alpha - \beta$ is not an integer multiple of 2π , then the value of $\sin\left(\frac{\alpha + \beta}{2}\right)$ is

Ans

1. $\frac{4}{3}$

2. $\frac{4}{25}$

3. $\frac{7}{10}$

4. $\frac{24}{25}$

Note: For this question, discrepancy is found in question/answer. So, This question is ignored for all candidates.

Question Type : **MCQ**

Question ID : **4146641037**

Status : **Not Answered**

Chosen Option : --

Marks : **0**

Q.10 Let P be a point, different from $(0, 0)$, on the parabola $y^2 = 4x$ whose focus is at F . Let T be the foot of the perpendicular drawn from P on to the directrix of the parabola. The least distance of the point $(0, 0)$ from the orthocentre of triangle PFT as P moves on the parabola is

Ans

 1. $\sqrt{2}$

 2. $\sqrt{3}$

 3. $\sqrt{5}$

 4. 2

Question Type : **MCQ**

Question ID : **4146641043**

Status : **Not Answered**

Chosen Option : --

Marks : **0**

Q.11

Let X be the set of all 6-digit numbers, where all the digits of each number are from the set $\{1, 2, 3, 4, 5\}$, and any digit that appears in any one of the numbers appears at least twice (in the same number). Then the number of distinct elements in the set X equals

Ans

 1. 1415

 2. 900

 3. 1800

 4. 1405

Question Type : **MCQ**

Question ID : **4146641036**

Status : **Not Answered**

Chosen Option : --

Marks : **0**

Q.12

Three different numbers are chosen at random from $\{1, 2, 3, 4, 5\}$ and arranged in increasing order . The probability that the resulting sequence is in arithmetic progression is

Ans

✗ 1.

$$\frac{3}{7}$$

✗ 2.

$$\frac{3}{10}$$

✗ 3.

$$\frac{2}{7}$$

✓ 4.

$$\frac{2}{5}$$

Question Type : MCQ

Question ID : 4146641044

Status : Not Answered

Chosen Option : --

Marks : 0

Q.13 A continuous function $f : \mathbb{R} \rightarrow \mathbb{R}$ is said to be good if given $a, b \in \mathbb{R}$ ($a < b$), the line segment joining the points $(a, f(a))$ and $(b, f(b))$ lies on or above the graph of f in the interval $[a, b]$. If f and g are functions defined on reals, then let $\max(f, g)$ be the function which takes the value $\text{maximum}\{f(x), g(x)\}$ at $x \in \mathbb{R}$. If f and g are good, then

Ans

✓ 1. $f + g$ is good

✗ 2. $f - g$ is good

✓ 3. $\max(f, g)$ is good

✗ 4. $f \circ g$ is good

Question Type : **MSQ**

Question ID : **4146641047**

Status : **Answered**

Chosen Option : **1,2,3,4**

Marks : **0**

Q.14 Let $S_k = \{z \in \mathbb{C} : z^2 + |z| = k\}$ for each $k \in \mathbb{Z}$. Then

Ans ✓ 1.

S_0 has more elements than any S_k , $k \neq 0$

✓ 2.

for $k > 0$, if $z \in S_k$ then $\text{Im}(z) = 0$

✓ 3.

$|\text{Arg}(z_1) - \text{Arg}(z_2)| = \pi$ for $z_1, z_2 \in S_k$ for any $k \neq 0$

✗ 4.

for $k > 0$, if $z \in S_k$ then $\text{Re}(z) = 0$

Question Type : **MSQ**

Question ID : **4146641046**

Status : **Answered**

Chosen Option : **1,3**

Marks : **0**

Q.15

Let $\mu(n)$ be the Möbius function defined for positive integers by

$$\mu(n) = \begin{cases} 1 & \text{if } n = 1 \\ 0 & \text{if } p^2 \text{ divides } n, \text{ for some prime number } p \\ (-1)^r & \text{if } n = p_1 p_2 \cdots p_r, \text{ with prime numbers } p_1 < p_2 < \cdots < p_r \end{cases}$$

Let m, n be positive integers > 1 . Then

Ans  1.

$$(\mu(n) + \mu(n^2))^2 = 1$$

 2.

$$(\mu(m) + \mu(n))^2 = 4\mu(m)\mu(n) \text{ if } \gcd(m, n) = 1$$

 3.

$$\text{If } \mu(n) \neq 0 \text{ and } n \text{ divides } m, \text{ then } \mu\left(\frac{m}{n}\right) = \frac{\mu(m)}{\mu(n)}$$

 4.

$$\mu(nm) = \mu(n)\mu(m) \text{ if } \gcd(m, n) = 1$$

Question Type : **MSQ**

Question ID : **4146641048**

Status : **Answered**

Chosen Option : **3**

Marks : **0**

Q.16

Let $f(x) = \sin x$ and $g(x) = \cos x$, $x \in \mathbb{R}$. Define $h(x) = \frac{f(g(x))}{g(f(x))}$. Then

Ans ✗ 1.

$h(x) > 0$ wherever $h(x)$ is well-defined

✓ 2.

domain of $\frac{1}{h(x)}$ is $\left\{ x \in \mathbb{R} : x \neq (2n + 1)\frac{\pi}{2}, n \in \mathbb{Z} \right\}$

✓ 3.

domain of $h(x)$ is \mathbb{R}

✓ 4.

$h(x) < 1$ wherever $h(x)$ is well-defined

Question Type : **MSQ**

Question ID : **4146641045**

Status : **Answered**

Chosen Option : **2,4**

Marks : **0**

Q.17

Consider the differential equation $\frac{dx}{dt} = |x(t)| + |x(t) - 1|$. Then the correct statement/ statements is/are

Ans

✓ 1. $x(0) = 1$, $x(1) = \frac{1}{2}(1 + e^2)$

✗ 2. $x(0) = 0$, $x(2) = \frac{1}{2}(1 + e^4)$

✗ 3. $x(0) = \frac{1}{2}$, $x(1) = \frac{3}{2}$

✗ 4. $x(0) = \frac{3}{2}$, $x(1) = \frac{1}{2} + \frac{1}{2}e^2$

Question Type : MSQ

Question ID : 4146641049

Status : Answered

Chosen Option : 3,4

Marks : 0

Section : Physics

Q.1 A body, placed in vacuum, starts cooling from the initial temperature of T_0 K. Let Δt be the time required to reduce the temperature to $T_0/2$ K. Then, the approximate time needed to cool the body from T_0 K to $T_0/3$ K is

Ans

 1. $3.5 \Delta t.$

 2. $3.7 \Delta t.$

 3. $3.9 \Delta t.$

 4. $4.1 \Delta t.$

Question Type : **MCQ**

Question ID : **4146641055**

Status : **Not Answered**

Chosen Option : --

Marks : **0**

Q.2 Water and ice having equal masses are placed inside an insulated container. The initial temperatures of water and ice are 40°C and 0°C respectively. The equilibrium temperature of the system in degrees Celsius is close to (Note: take the specific heat of water = $4000 \text{ J}\cdot\text{kg}^{-1}\cdot\text{K}^{-1}$; latent heat of fusion = $300 \text{ kJ}\cdot\text{kg}^{-1}$)

Ans

 1. 10

 2. 0

 3. 4

 4. 20

Question Type : **MCQ**

Question ID : **4146641050**

Status : **Not Answered**

Chosen Option : --

Marks : **0**

Q.3 Three objects, a hollow cylinder, a solid cylinder and a solid sphere are released from the top of an inclined plane. The objects, having equal masses and radii, roll without slipping while coming down the plane. Arrange these objects in the descending order of time required to reach the bottom of the plane (slowest to fastest).

Ans  1.

All three objects will take the same time to reach the bottom.

 2.

Hollow cylinder, solid cylinder, solid sphere.

 3.

Hollow cylinder, solid sphere, solid cylinder.

 4.

Solid cylinder, hollow cylinder, solid sphere.

Question Type : **MCQ**

Question ID : **4146641052**

Status : **Answered**

Chosen Option : **1**

Marks : **-1**

Q.4 A wire of length L and cross-sectional area A has resistance R . It carries a current I when a voltage V is applied to its ends. The wire is melted and drawn to double its length. If the same voltage were to be applied across the wire then

Ans  1.

the resistance in the wire will be $R/4$.

 2.

the resistance in the wire will be $2R$.

 3.

the current in the wire will be $2I$.

 4.

the current in the wire will be $I/4$.

Question Type : **MCQ**

Question ID : **4146641051**

Status : **Not Answered**

Chosen Option : --

Marks : **0**

Q.5 Three spherical balls having mass m_1, m_2 and m_3 are placed one on top of another with their centre of masses aligned as shown in the figure below.

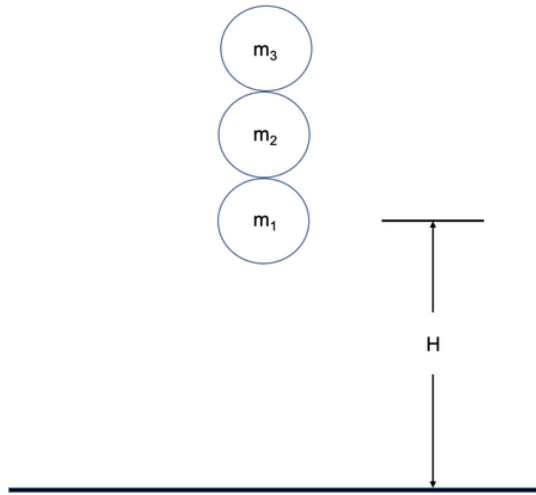

These balls are dropped together from height H . The radii of balls are negligibly small in comparison with height H . The heights to which the masses will rebound is expressed as $H_r = \chi H$. Assuming that all collisions (including the collision between m_1 and the floor) are elastic and $m_1 \gg m_2 \gg m_3$, the values of χ for masses m_1, m_2 and m_3 are given by

- Ans**
- ✓ 1. $(1, 9, 49)$
 - ✗ 2. $(1, 9, 27)$
 - ✗ 3. $(1, 1, 1)$
 - ✗ 4. $(1, 4, 9)$

Question Type : **MCQ**

Question ID : **4146641053**

Status : **Not Answered**

Chosen Option : --

Marks : **0**

Q.6

In a photoelectric setup electrons of maximum kinetic energy 0.5 eV and 1.3 eV are liberated when ultraviolet light of wavelengths 310 nm and 250 nm respectively are employed. Then the calculated value of the Planck constant is closest to

Ans

✗ 1. $4.5 \times 10^{-34} \text{ J}\cdot\text{s}$

✗ 2. $7.5 \times 10^{-34} \text{ J}\cdot\text{s}$

✓ 3. $5.5 \times 10^{-34} \text{ J}\cdot\text{s}$

✗ 4. $6.5 \times 10^{-34} \text{ J}\cdot\text{s}$

Question Type : **MCQ**

Question ID : **4146641060**

Status : **Not Answered**

Chosen Option : --

Marks : **0**

Q.7 A jeweller examines a 1.0 cm diamond through a small magnifying glass (called a loupe) having an angular magnification of 3.5. The near point of her eye is 25.0 cm and she wants the image to be located at the near point. The focal length of the loupe should be

Ans

✗ 1. 3.5 cm.

✗ 2. 1.0 cm.

✓ 3. 10.0 cm.

✗ 4. 25.0 cm.

Question Type : **MCQ**

Question ID : **4146641056**

Status : **Not Answered**

Chosen Option : --

Marks : **0**

Q.8

The population $N(t)$ of ill patients during an epidemic in a country is given by the following equation

$$N(t) = \frac{N_0 \exp(t/\tau)}{1 + N_0(\exp(t/\tau) - 1)/N_s}$$

where N_0 is the initial population of ill patients, $N_s \gg N_0$ is a large number and τ is a positive constant. The sketch which describes it best is

Ans

1.

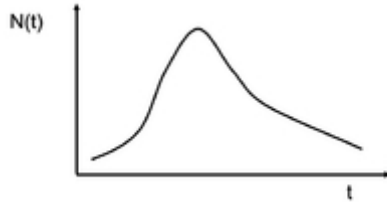

2.

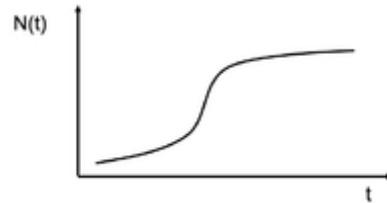

3.

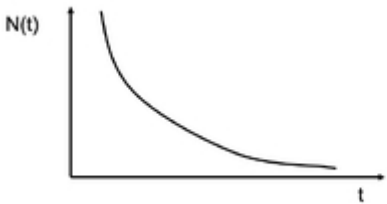

4.

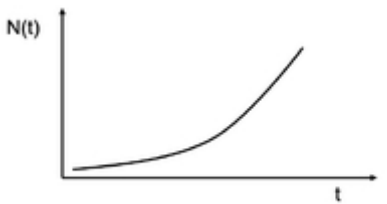

Status : **Not Answered**

Chosen Option : --

Marks : **0**

- Q.9** A long wire with a uniform linear charge density λ is placed along the common axis of two long coaxial thin cylindrical shells of radii R_1 and R_2 (see figure). The outer shell carries a uniform surface charge density $-\lambda/2\pi R_2$. Take the zero of the potential at infinity along the radial direction. The potential at a distance r from the axis where $R_1 < r < R_2$ is

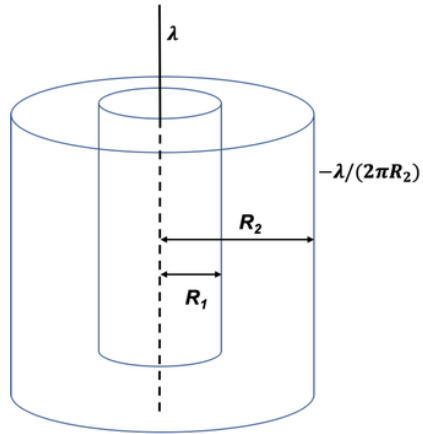

Ans

- ✗ 1. $\frac{\lambda}{4\pi\epsilon_0} \ln(R_2/r)$.
- ✓ 2. $\frac{\lambda}{2\pi\epsilon_0} \ln(R_2/r)$.
- ✗ 3. $\frac{\lambda}{2\pi\epsilon_0} \ln(r/R_2)$.
- ✗ 4. $\frac{\lambda}{4\pi\epsilon_0} \ln(r/R_2)$.

Question Type : MCQ

Question ID : 4146641058

Status : Not Answered

Chosen Option : --

Marks : 0

Q.10

A parallel beam of light, linearly polarized along the y -axis, passes through a combination of convex lenses and mirrors as shown in the figure. The output beam

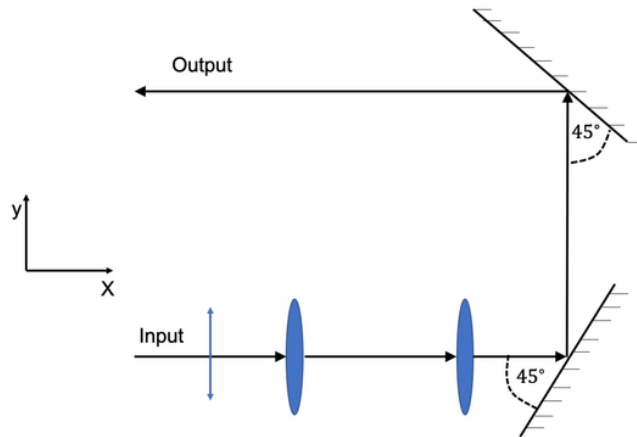

Ans 1.

will be polarized along the z -axis.

2.

will be polarized along a line making an angle of 45° with the y -axis.

3.

will be polarized along the y -axis.

4.

will be unpolarized.

Question Type : MCQ

Question ID : 4146641057

Status : Not Answered

Chosen Option : --

Marks : 0

Q.11 Consider an atomic species of atomic number Z and consisting of three electrons which are orbiting equally spaced in the same circular orbit. Let a_B be the Bohr radius and let the Bohr quantization rule hold for each electron. Then the ground state radius of the three electron atom is

Ans

✗ 1. $\frac{a_B}{Z - 1/3}$

✗ 2. $\frac{a_B}{Z - 2/3}$

✗ 3. $\frac{a_B}{Z - \sqrt{2/3}}$

✓ 4. $\frac{a_B}{Z - 1/\sqrt{3}}$

Question Type : **MCQ**

Question ID : **4146641059**

Status : **Not Answered**

Chosen Option : --

Marks : **0**

Q.12 The variation in the atmospheric pressure with height can be estimated by balancing force due to gradient in pressure with the gravity. Assume ideal gas behaviour, isothermal conditions with temperature $T = 290\text{ K}$, and constant composition of air throughout the atmosphere. The approximate percentage reduction in oxygen at a height of 1 km above sea level is (note: take the mean molecular mass of air at the sea level as $29\text{ gm}\cdot\text{mol}^{-1}$)

Ans

1. 13

2. 11

3. 9

4. 15

Question Type : **MCQ**

Question ID : **4146641054**

Status : **Not Answered**

Chosen Option : --

Marks : **0**

Q.13 The inhalation and exhalation processes of breathing are modelled using a relationship between the gauge pressure (P) and volume (V) of lungs as $V = A [1 - \exp(-kP)]$ where A and k are the positive constants (see figure for a schematic sketch). For a healthy human adult, during inhalation $A = 3.57 \times 10^{-3} \text{ m}^3$ and $k = 0.964 \times 10^{-3} \text{ Pa}^{-1}$. The corresponding values during exhalation are given as $A = 3.35 \times 10^{-3} \text{ m}^3$ and $k = 1.644 \times 10^{-3} \text{ Pa}^{-1}$. The maximum volume of lungs (at the end of inhalation) is approximately equal to $3.31 \times 10^{-3} \text{ m}^3$ and the pressure at the maximum volume is $2.717 \times 10^3 \text{ Pa}$. Assuming air to be an ideal diatomic gas, choose the correct statement(s).

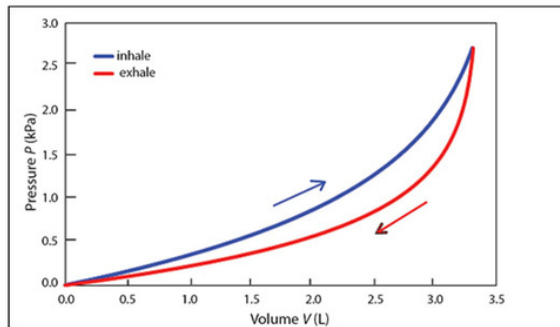

Ans ✓ 1.

The net work done by human body during one complete inhale-exhale cycle is approximately 0.82 J

✗ 2.

dP/dV is zero at the beginning of the inhalation process.

✓ 3.

The model assumes that volume of lung collapses to zero at the absolute pressure equal to atmospheric pressure.

✓ 4.

The heat input during inhale process is around 25 J.

Question Type : **MSQ**

Question ID : **4146641063**

Status : **Answered**

Chosen Option : **2,3**

Marks : **0**

Q.14 A long straight wire carries a 2.0 A current. A small rectangular coil of dimensions $5.0 \text{ cm} \times 4.0 \text{ cm}$ is placed at a distance of 2.0 m from the wire. The wire is in the same plane as the coil. The coil has $n = 250$ turns. Assume that the magnetic field due to the current is uniform over the coil. Then

Ans  1.

the mutual inductance between the wire and the coil will be doubled if the current in the wire is doubled.

 2.

the magnitude of the magnetic field due to the wire at the coil is $2.0 \times 10^{-7} \text{ T}$.

 3.

the mutual inductance between the wire and the coil will be doubled if the coil is placed at a distance of 1.0 m.

 4.

the mutual inductance between the wire and the coil is proportional to n .

Question Type : **MSQ**

Question ID : **4146641065**

Status : **Answered**

Chosen Option : **2,4**

Marks : **0**

Q.15

A particle with an initial kinetic energy E_0 approaches the origin from $x = +\infty$ in the presence of a conservative potential. Consider following expressions for the corresponding potential energy $V(x)$ where x is in meters:

(i) $V(x) = E_0 [1 + \exp\{-(x/x_0)^2\}]$

(ii) $V(x) = E_0 [1 + 1.5 \exp\{-((x - 5)/x_0)^2\}]$

(iii) $V(x) = E_0 [1 - 0.5 \exp\{-((x - 5)/x_0)^2\}]$

(iv) $V(x) = \frac{E_0}{((x - 10)/x_0)^2} [1 - 0.5 \exp\{-((x - 5)/x_0)^2\}]$

Here $x_0 = 1$ m. Select the correct statement(s):

Ans  1.

The particle will reverse its direction on reaching $x = 5$ m for the potential energy given by expression (ii).

 2.

The particle will reach $x = 10$ m for the potential energy given by expression (iv).

 3.

The particle will reach the origin for the potential energy given by expression (iii).

 4.

The speed of the particle will decrease monotonically as the particle approaches the origin for the potential energy given by expression (i).

Question Type : **MSQ**

Question ID : **4146641062**

Status : **Answered**

Chosen Option : **2,4**

Marks : **0**

Q.16 The photon flux of a one curie gamma ray source incident on a human tissue of cross-sectional area 1.0 cm^2 decreases exponentially with tissue depth x

$$I(x) = I_0 \exp(-\mu x)$$

where μ is the attenuation constant and I is the flux. Let $E = 1 \text{ MeV}$ be the average energy of the incident gamma ray photon and σ be the surface mass density of the tissue. Select the correct statement(s): (One curie is 3.7×10^{10} disintegrations per second)

Ans  1.

$E I_0$ is of order 0.1 Watt/m^2 .

 2.

At a distance of $x = 3/\mu$ I is close to $0.37 I_0$.

 3.

$E I / \sigma$ has dimensions of $\text{L}^2 \text{ T}^{-3}$.

 4.

The attenuation constant for beta rays will be larger than that for photons of similar energy.

Question Type : **MSQ**

Question ID : **4146641066**

Status : **Answered**

Chosen Option : **3,4**

Marks : **4**

Q.17

An electron beam of energy 150 eV is incident normally on a Young's double slit setup. The distance between the slits is 0.1 mm and the distance between the slits and the screen is 1 m. Neglect gravity and electron-electron interactions. Select the correct statement(s).

Ans  1.

The de Broglie wavelength of the electron in the beam is of the same order as the wavelength of visible light.

 2.

The fringe width will be less than 0.0001 m.

 3.

The energy of the electron in this beam is of the same order as the rest mass energy of the electron.

 4.

The momentum of the electron in the beam is of order $10^{-24} \text{ kg}\cdot\text{m}\cdot\text{s}^{-1}$.

Question Type : **MSQ**

Question ID : **4146641064**

Status : **Answered**

Chosen Option : **1,4**

Marks : **0**